

**PHILIPS**

hue personal  
wireless  
lighting

Enrave S



HUE serial number



User manual  
Benutzerhandbuch  
Notice d'emploi  
Manual de usuario  
Manual do usuário  
Manuale d'uso

# Enrave S

Incl.



1 x CR2032 +

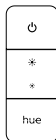

Excl.

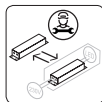
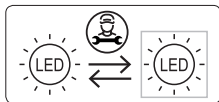
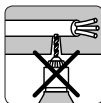
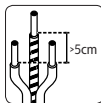
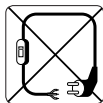
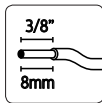
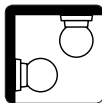
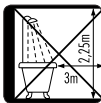
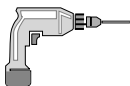

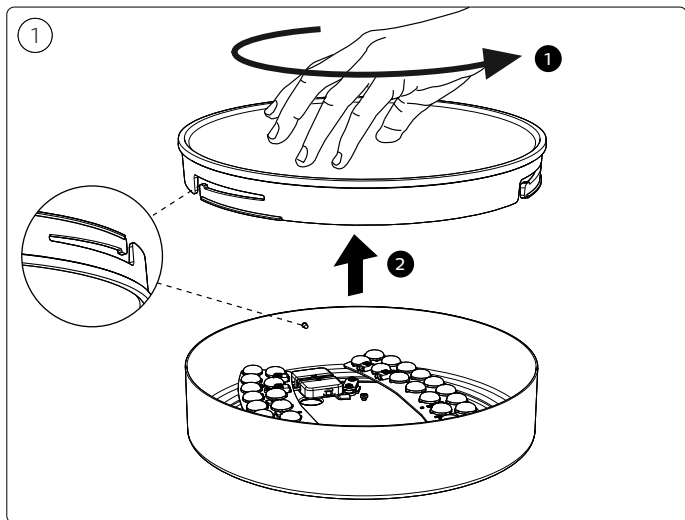
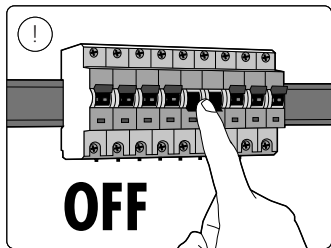

2

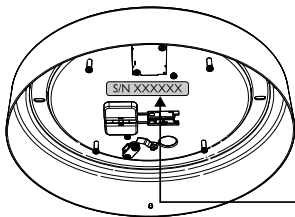

HUE serial number

3a

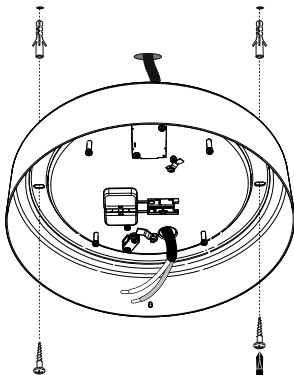

3b

NL

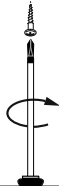
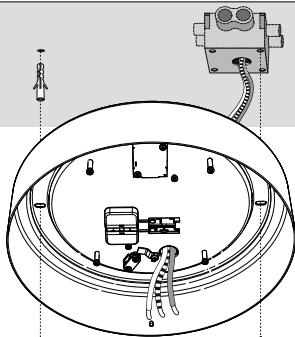

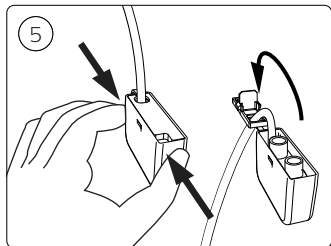
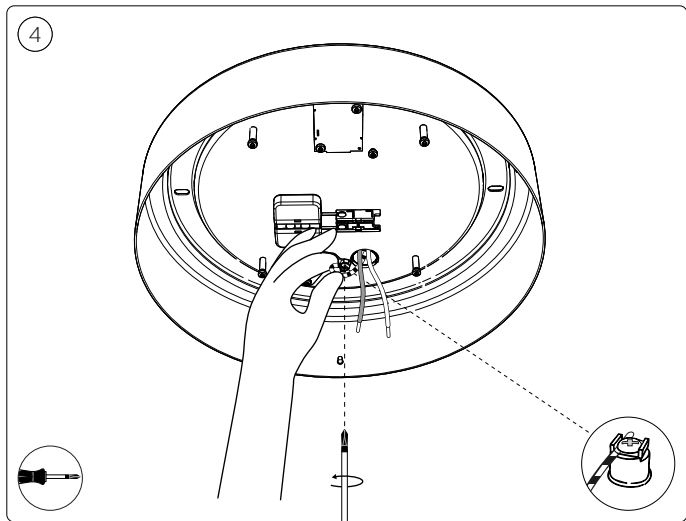

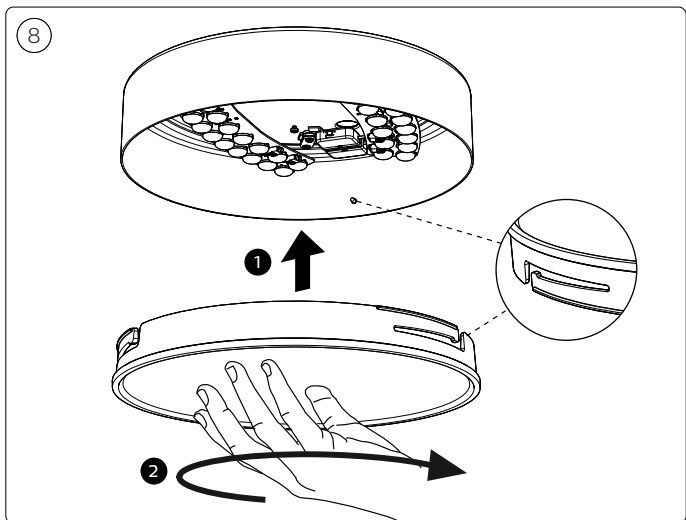
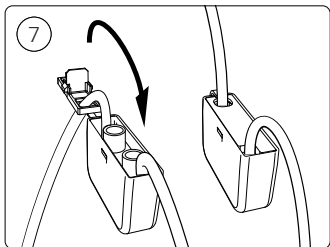
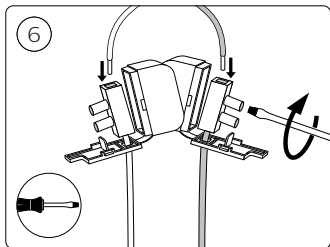

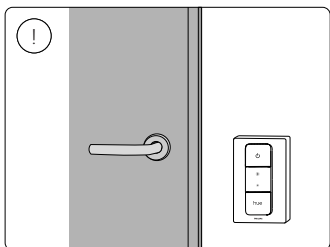
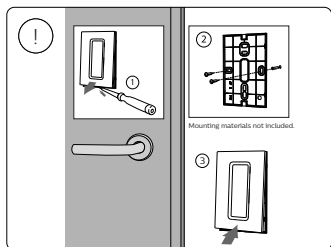
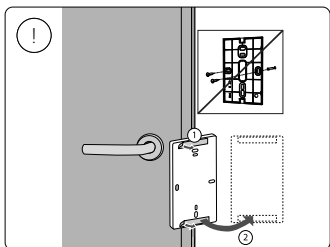
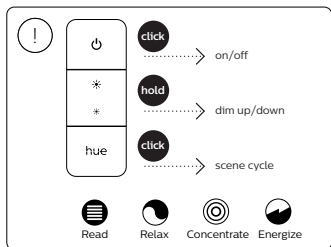
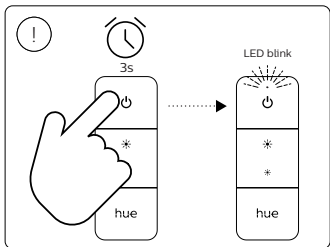
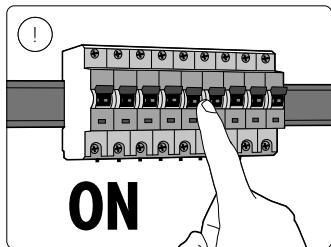



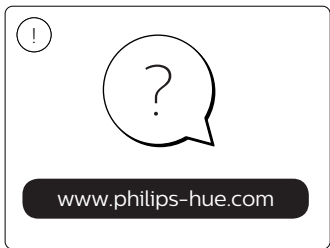
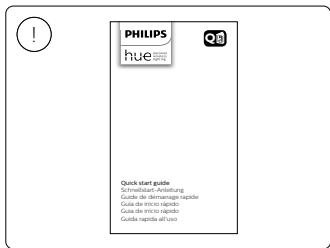
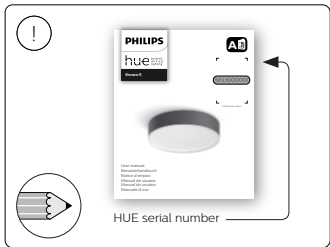
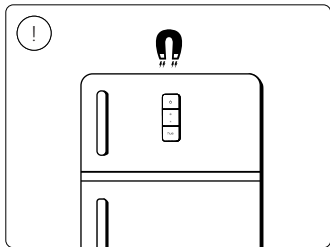







Signify  
I.B.R.S. / C.C.R.I. Numéro 10461  
5600 VB Eindhoven,  
the Netherlands  
☎00800-74454775

© 2021 Signify Holding  
All rights reserved

[www.philips-hue.com](http://www.philips-hue.com)

4422 954 75811  
Last update: 02/2021